

**LUDLUM MODEL 3019 & 3006
BACKGROUND SURVEY METER
USER'S MANUAL**

September 2019

**Serial Number 25009185 and Succeeding
Serial Numbers**

LUDLUM MODEL 3019 & 3006 BACKGROUND SURVEY METER USER'S MANUAL

September 2019

**Serial Number 25009185 and Succeeding
Serial Numbers**



LUDLUM MEASUREMENTS, INC
501 OAK STREET, P.O. BOX 810
SWEETWATER, TEXAS 79556
325-235-5494, FAX: 325-235-4672

STATEMENT OF WARRANTY

Ludlum Measurements, Inc. warrants the products covered in this manual to be free of defects due to workmanship, material, and design for a period of twelve months from the date of delivery. The calibration of a product is warranted to be within its specified accuracy limits at the time of shipment. In the event of instrument failure, notify Ludlum Measurements to determine if repair, recalibration, or replacement is required.

This warranty excludes the replacement of photomultiplier tubes, G-M and proportional tubes, and scintillation crystals which are broken due to excessive physical abuse or used for purposes other than intended.

There are no warranties, express or implied, including without limitation any implied warranty of merchantability or fitness, which extend beyond the description of the face there of. If the product does not perform as warranted herein, purchaser's sole remedy shall be repair or replacement, at the option of Ludlum Measurements. In no event will Ludlum Measurements be liable for damages, lost revenue, lost wages, or any other incidental or consequential damages, arising from the purchase, use, or inability to use product.

RETURN OF GOODS TO MANUFACTURER

If equipment needs to be returned to Ludlum Measurements, Inc. for repair or calibration, please send to the address below. All shipments should include documentation containing return shipping address, customer name, telephone number, description of service requested, and all other necessary information. Your cooperation will expedite the return of your equipment.

**LUDLUM MEASUREMENTS, INC.
ATTN: REPAIR DEPARTMENT
501 OAK STREET
SWEETWATER, TX 79556**

**800-622-0828 325-235-5494
FAX 325-235-4672**

REVISION HISTORY

REV	DESCRIPTION	DATE	BY
1	VALID	3/21/14	DDW
2	ECF# 3778	10/8/15	WJM
3	ECF# 3951	1/13/16	WJM

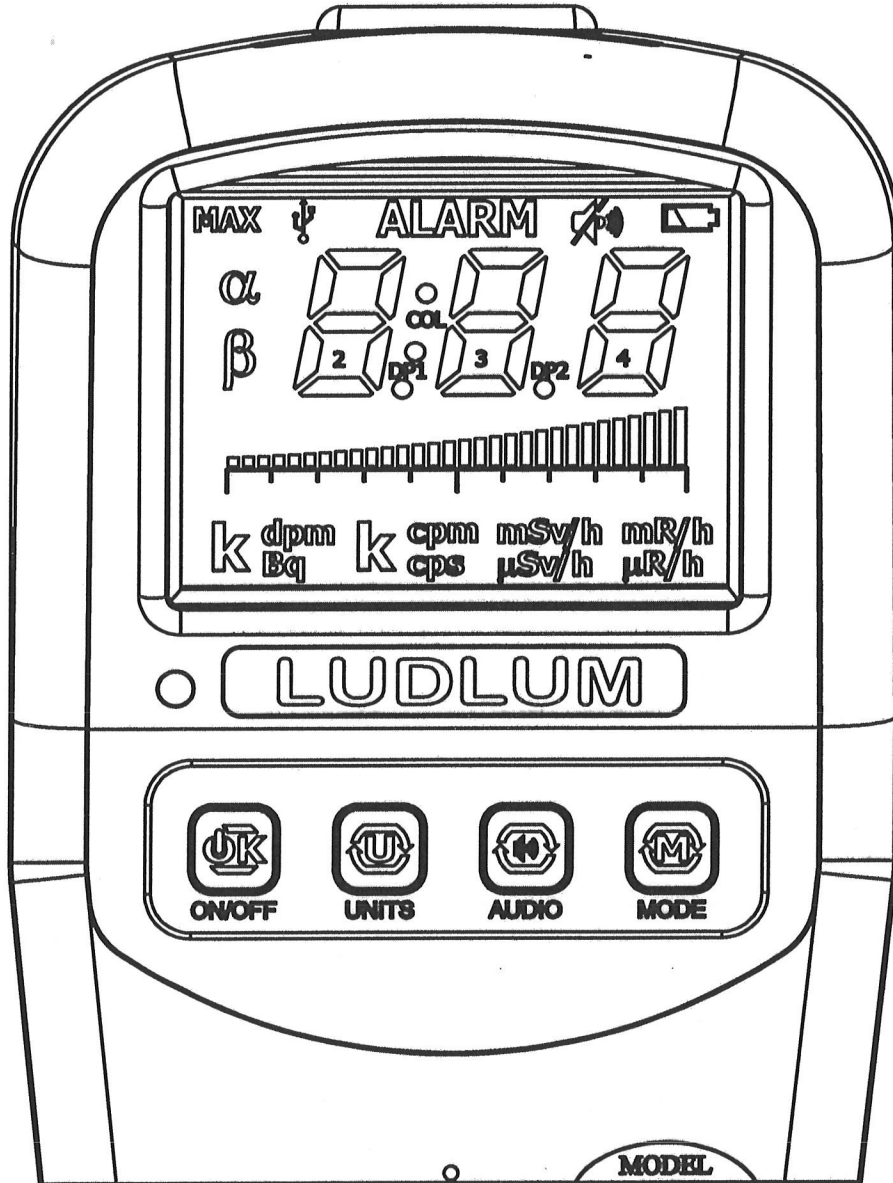

DWN	DATE	CHK	DATE	APP	DATE
WJM	5/26/16			WJM	5-26-16
DWG NUM: 4498-593				SCALE: 1:1	
TITLE M 3019 FRONT PANEL					
 LUDLUM MEASUREMENTS, INC. 501 OAK STREET SWEETWATER, TEXAS 79556			SERIES	SHEET	
			498	593J	

REVISION HISTORY			
REV	DESCRIPTION	DATE	BY
1	VALID	3/21/14	DDW
2	ECF# 3778	10/8/15	WJM
3	ECF# 3951	1/13/16	WJM

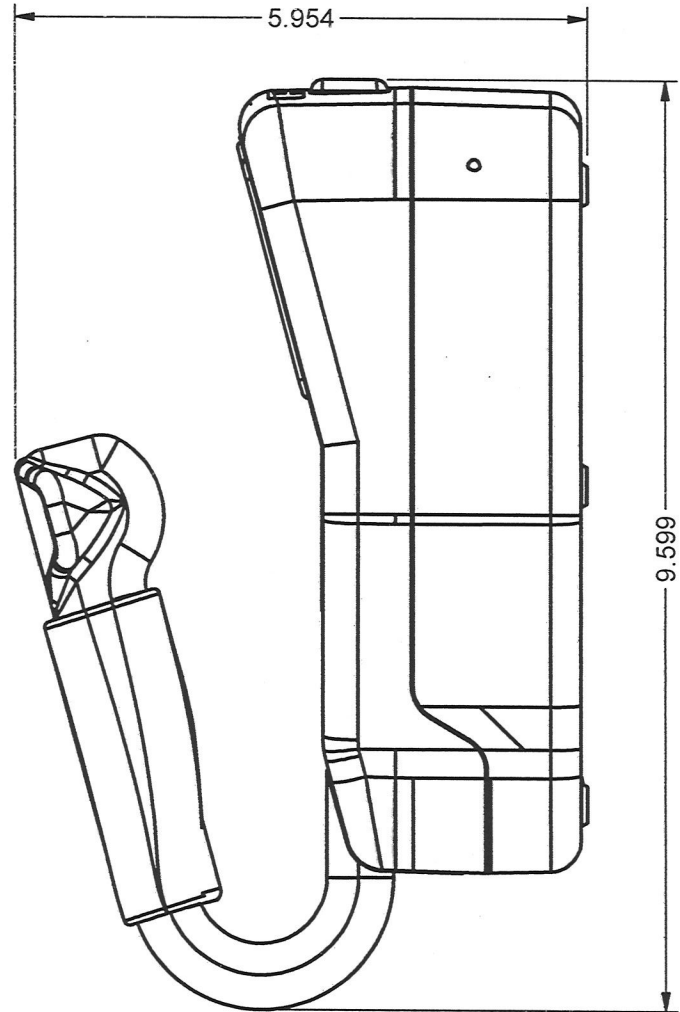
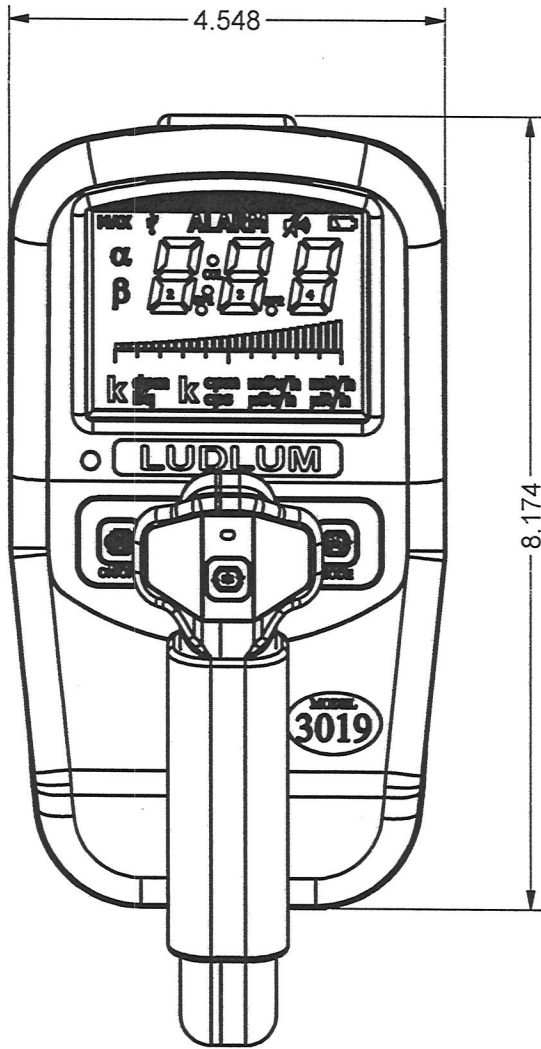

DWN	DATE	CHK	DATE	APP	DATE
WJM	5/26/16			WJM	5-26-16
DWG NUM: 4498-593				SCALE: 1/2	
TITLE M 3019 OVERALL DIMENSIONS					
 LUDLUM MEASUREMENTS, INC. 501 OAK STREET SWEETWATER, TEXAS 79556		SERIES	SHEET		
		498	593K		

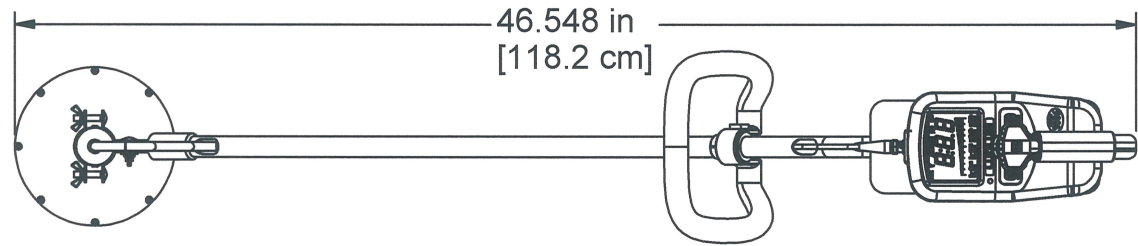

REVISION HISTORY			
REV	DESCRIPTION	DATE	BY
1	VALID	9-19-17	CMC

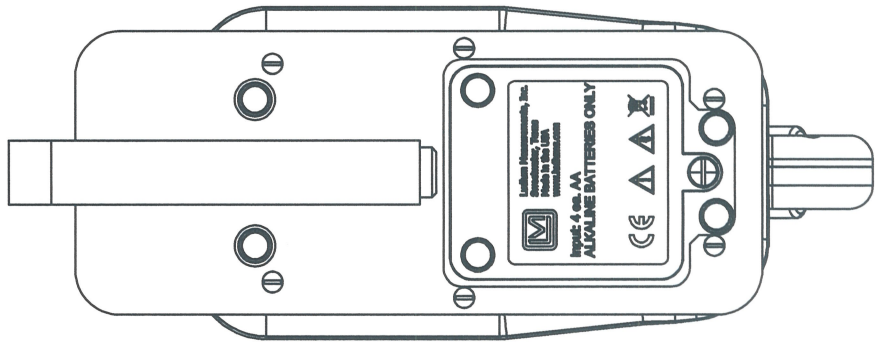
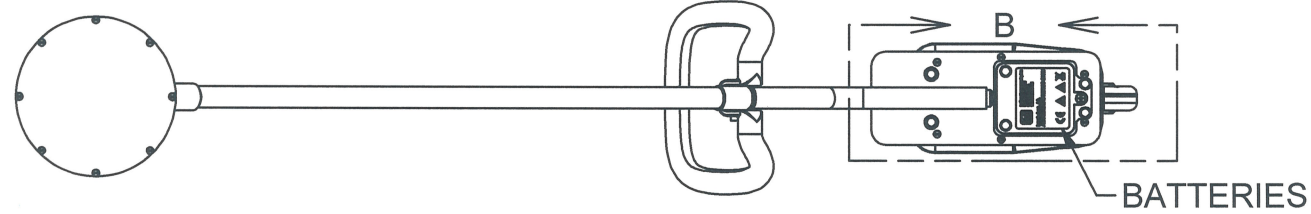
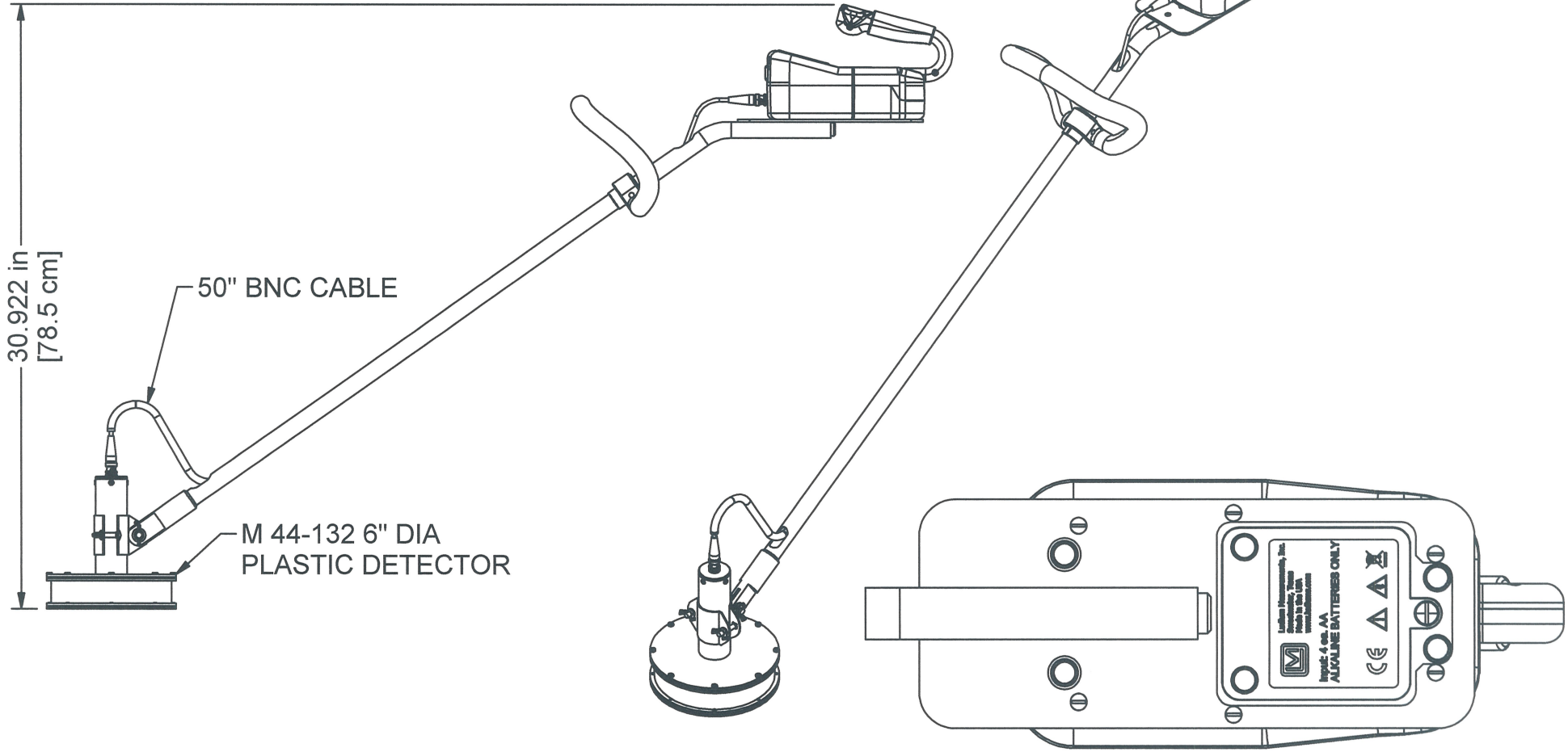

DETAIL B
SCALE 3/8

DWN	DATE	CHK	DATE	APP	DATE
CMC	9-19-17			J6w	9-19-17
DWG NUM: 4519-130				SCALE: 1/8	
TITLE M 3006 OVERALL					
LUDLUM MEASUREMENTS, INC. 501 OAK STREET SWEETWATER, TEXAS 79556				SERIES 519	SHEET 130A

Table of Contents

<i>Introduction</i>	1
<i>Getting Started</i>	2
Unpacking and Repacking	2-1
Battery Installation	2-1
Instrument Operational Test	2-2
Sigma Audio	2-4
Detector Failure Diagnostic	2-5
Detector Over Range	2-5
Detector Overload	2-6
Instrument Use and Controls	2-6
RATE Mode Operation	2-9
MAX Mode Operation	2-10
COUNT Mode Operation	2-11
<i>Specifications</i>	3
<i>Setup Mode</i>	4
Setup Overview	4-1
Default Setup Values	4-2
Entering Setup Mode	4-3
Setup Mode Operation	4-5
<i>Datalogging</i>	5
Datalogging Operation – Mode 1	5-2
Datalogging Operation – Mode 2	5-3
Datalogging Operation – Mode 3	5-4
Specifications	5-4
<i>Software</i>	6
Connecting to Software	6-1

Extended Features	6-2
<i>Advanced Features</i>	7
Dead Time Correction	7-1
Units	7-2
Software Calibration Tools	7-3
Instrument Calibration	7-3
Other Device Data	7-3
Real-time Streaming	7-4
<i>Safety Considerations</i>	8
Environmental Conditions for Normal Use	8-1
Warning Markings and Symbols	8-1
Cleaning and Maintenance Precautions	8-2
<i>Revision History</i>	9
<i>Recycling</i>	10
<i>Options</i>	11
<i>Energy Response</i>	A
Model 3019 Energy Response	A-1
Model 3006 Energy Response	A-2

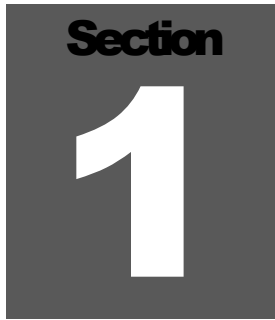
A dark gray square graphic with the word "Section" in white at the top and a large white number "1" in the center.

Introduction

The Model 3019 is an ergonomic, lightweight instrument with an internal detector used for gamma radiation survey for background to 500 $\mu\text{Sv/h}$ (50 mR/hr). It features alarm points that can be set through Setup Mode using the onboard keypad, or alternately via the optional software by USB connection. The Sigma Audio feature assists search efforts by responding with an audible alarm when it detects above-normal radiation.

Three modes of operation are available for the Model 3019 – RATE, MAX, and COUNT. RATE mode operation will display the current exposure, or dose rate. MAX mode is used to capture the highest exposure or dose rate detected – useful for finding a peak rate when the display is not visible. Two sets of units (primary and secondary) for RATE and MAX modes can be chosen from among cps, cpm, Bq, dpm, R/h, or Sv/h. The user can switch between these two units by simply tapping the Units button. If not needed, the second set of units can be disabled. Also, the additional MAX and COUNT modes may also be disabled, reducing the possible number of displays the user may confront.

COUNT mode allows the user to perform a count for a predetermined time. Depending on the count units chosen, the result can be a scaler count (in counts or disintegrations), a time-averaged rate (cpm, dpm, Bq, cps), a time-averaged exposure or dose (R/h, Sv/h), or an integrated exposure or dose (R or Sv).

The instrument features a large backlit LCD (liquid crystal display), a piercing audio warning, and easy, intuitive use. The unit body is made of lightweight but durable plastic. It is intended for outdoor use and can resist splashing water.

The display will be automatically backlit if light levels are low. The display backlight can also be configured for “Continuous On” operation. RATE and MAX modes can be silent or utilize a “click” audio; the “click” audio is disabled in COUNT mode by default, but can

be enabled through software. A "sigma" audio mode is enabled (disabling the "click" audio), making it easy for the user to find small increases above the background radiation level. In this mode, the instrument measures background for 8 seconds after power-up, and then beeps whenever the rate increases by a small amount. Users are freed from watching the numeric value to "find" something. They can simply listen for multiple beeps.

Setup of the instrument is accomplished through the front-panel buttons, or through software available from Ludlum Measurements. The advanced user or administrator can set:

- Calibration Constant
- Dead Time Correction 1
- Dead Time Correction 2
- Efficiency
- High Voltage
- Pulse Threshold
- Detector Current Overload Threshold
- Loss of Count Alarm Time
- Primary and Secondary Units
- Primary and Secondary Minimum and Maximum Displays
- Primary and Secondary Unit Alarm Levels
- Primary and Secondary Count Units
- Primary and Secondary Count Units Minimum Displays
- Primary and Secondary Count Alarm Levels
- Response Time
- Auto-Response Rate (**F**ast or **S**low)
- Available Operational Modes
- Count Time
- Auto Shutdown Time
- Backlight Threshold
- Sigma or Click Audio Mode

Dead time correction coefficients can be configured either through the device setup menu or through a wizard included in the calibration software. Dead time correction employs first and second order corrections for extended performance.

The Model 3019 comes with the ability to log measurements to memory for later download. The optional Ludlum Lumic Datalog software is needed to download this memory, however. The unit can log up to 1000 measurements. It adds a date/time stamp to each measurement.

Front-panel setup can be disabled via the internal switch on the Model 3019 in order to protect settings from inadvertent changes.

The unit is operated with four alkaline AA batteries for operation from -20 to 50 °C (-5 to 122 °F). Battery life is approximately 750 hours under normal usage. A low-battery indicator on the LCD warns when less than 16 hours of battery life remain.

The Model 3006 has similar basic instrument and electronics, but is attached to a pole and has a plastic scintillator detector mounted at the end of the pole. The extended-reach pole allows for surveying trucks, scrap metal, and other areas of concern for gamma or X-ray radiation. (See photos below.)

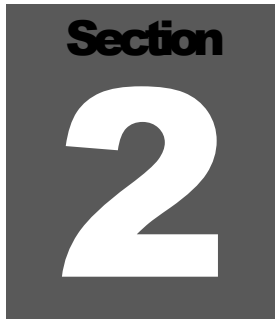

A dark gray square with the word "Section" in white at the top and a large white number "2" in the center.

Getting Started

Unpacking and Repacking

Remove the calibration certificate and place it in a secure location. Remove the instrument and ensure that all of the items listed on the packing list are in the carton. Check individual item serial numbers and ensure calibration certificates match between instruments and detectors (if applicable). The serial number of the instrument is located on a label on the front side of the unit.

To return an instrument for repair or calibration, provide sufficient packing material to prevent damage during shipment.

Every returned instrument must be accompanied by an **Instrument Return Form**, which can be downloaded from the Ludlum website at www.ludlums.com. Find the form by clicking the “Support” tab and selecting “Repair and Calibration” from the drop-down menu. Then choose the appropriate Repair and Calibration division where you will find a link to the form.

Battery Installation

A low-battery indicator appears at the bottom of the LCD when less than 16 hours of battery life remain. When this indicator is present, follow these steps to replace the four standard AA batteries:

1. Turn the instrument over so that the bottom of the instrument is facing up.
2. Use a straight medium-sized screwdriver to turn the single screw on the battery cover one quarter-turn counter-clockwise.
3. Release and remove the battery cover.
4. Replace four AA batteries.
5. Replace the cover and turn screw one quarter-turn clockwise to secure.

Instrument Operational Test

Turn the instrument ON by pressing the ON/OFF button for about a second, and then releasing.

The instrument should activate all the LCD segments and the audio. Observe the device during this time. If any LCD segments are missing, or audio fails to work, the device is in need of repair. Please refer to Figure 1 below.

Figure 1: Startup display with all LCD segments shown.

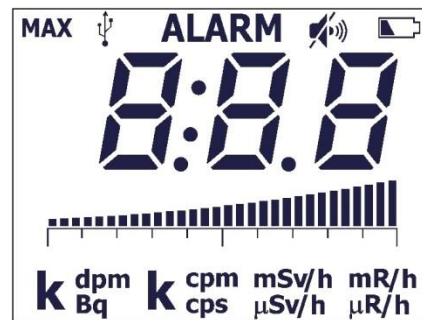

The instrument then displays the firmware version. Please refer to Figure 2 below.

Figure 2: Firmware version display.



Note: Firmware Versions with the Bq displayed support auxiliary communication.

The instrument then displays the battery voltage. Please refer to Figure 3 below.

Figure 3: Battery Voltage display



The instrument then displays the number of stored records if data logging is enabled. Please refer to Figure 4 below.

Figure 4: Startup display for optional data logging firmware, showing 155 stored records.



The instrument will then move to normal operation, displaying the current rate for the Primary units (default: $\mu\text{R}/\text{hr}$).

If the Sigma Audio option is selected, the unit will display a countdown from :08 to :01 (in seconds) as the unit measures background radiation levels.

The user may select the Secondary units (default: cpm) by tapping the Units button.

Ensure that the low-battery indicator is not present. If the low-battery indicator is present, replace the batteries as soon as possible. Should the instrument detect a battery voltage that is high enough to power on, but too low to safely operate, the display will blank and the low-battery icon will flash. Normal operation will not be available until the batteries have been replaced. Under extreme low-battery conditions, be aware that the unit may not even turn on or may turn itself off abruptly.

A reference reading with a check source, 1 μCi (37 kBq) of ^{137}Cs for example, should be obtained at the time the instrument is received in the field. Small check sources of radiation are available from Ludlum Measurements. While exempt from many regulations because of their small size, these sources are large enough to produce a response on this instrument. If this procedure is done routinely with the same radiation source, instrument malfunction may be detected when anomalous readings are observed. If at any time the instrument fails to read within 20% of the reference reading when using the same check source, it should be sent to a calibration facility for recalibration and/or repair.

Example log reading:

Check Source # _____ Rate _____ Units _____

Once this procedure has been completed, the instrument is ready for use.

Sigma Audio

The Ludlum Model 3006 & 3019 has the standard "click" audio that is widely used by radiation instruments. However, it also has a Sigma Audio mode that can be enabled to change the audio sound. This mode is useful for scintillation detectors because their high count rate makes the "click" audio less useful. In the sigma audio mode, the instrument measures the background radiation for eight seconds on power-up, and then automatically sets a low threshold rate above the background rate. Then the instrument will produce a beep any time that the instrument "sees" more than this threshold value. The user is not required to watch the display to find a small increase over background, but may simply listen for multiple beeps. Thus the unit has an audio alarm that, on power-up, adjusts to just above the current background level and provides a sensitive audio indication to the user. Note that this audio alarm can also work in conjunction with the fixed alarm, i.e. the user can have both a floating audio alarm (resulting in audio beeps) based on the background level, as well as a fixed tone audio and a steady ALARM icon when a predetermined fixed alarm level is exceeded.

Detector Failure Diagnostic

Note that the Model 3006 & 3019 have their own diagnostic tests to ensure that the detector is functioning correctly. The instrument can detect when the radiation detector is malfunctioning and will flash the display to indicate a fault. If the detector stops detecting radiation for a settable number of seconds, the instrument will flash a zero reading for the currently selected units. This indication is common if the unit is powered up without a detector connected. If this indication is observed with a connected detector, remove the unit from service and have it evaluated by a qualified repair and calibration technician.

Figure 5: Detector Failure display (shown for cpm) will also flash.

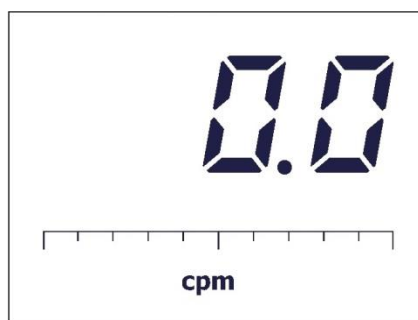

Detector Over Range

If the detector is exposed to high levels of radiation or has an internal malfunction that causes it to count high or excessively, the unit flashes the maximum rate (999) for the currently selected units as a warning. The user should ensure whether this is being caused by a high radiation field or by internal malfunction. With some detectors, this display could be an indicator of a light leak, possibly caused by a puncture or tear in the detector face. If a Maximum Display parameter is set, then it is possible for the display to flash the Maximum Display value under this condition.

Figure 6: Detector Over Range (shown for cpm) will also flash.

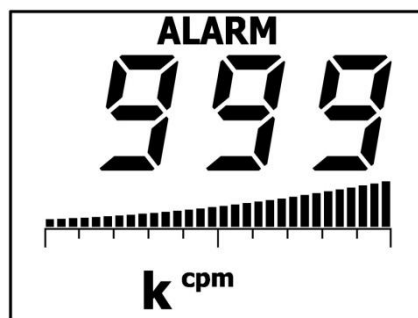

Detector Overload

As another diagnostic test, the Model 3006 and 3019 monitors the HV supply's detector current. A current overload threshold can be set via Setup Mode. (A setting of 0 disables this alarm.) In general, this alarm setting can be used to detect when there is some detector failure, a cable failure, or a possible high level of radiation. When this alarm is triggered, the LCD will display OL and an alarm tone will sound. Once the detector current goes below the threshold, the instrument will return to normal operation.

Figure 7: Detector Overload Alarm will also flash.



Instrument Use and Controls

With four front-panel buttons, the Ludlum Model 3006 and 3019 are simple and easy to use with minimal training required. Default operation is RATE mode, and the display shows the current count rate using the Primary units. Long-pressing the UNITS button will switch between Primary and Secondary units. Long-pressing the MODE button will switch the instrument to MAX mode, which will display the highest count rate detected. Long-pressing the MODE button again will switch it to COUNT mode, which will display the COUNT timer. Note that either or both of the MAX and COUNT modes can be locked out in the setup process.

See the **Model 3019 drawing at the beginning of this manual to reference the following controls:**

There are two types of button presses for each button described below:

ON/OFF button: Used to power the Model instrument ON and OFF, reset MAX mode, start/reset the COUNT Timer, and acknowledge audio alarms.

- Power On: Press for approximately one-half of a second and release (all LCD segments will activate, and firmware version will be shown).
- Power Off: Press for approximately four seconds. The display will show a 3, 2, 1 countdown for the final three seconds of shutdown. Releasing the ON/OFF button during shutdown will return the device to the previous state of operation. At completion of the shutdown count, the LCD will go blank.

Short Tap (tap-pressing the button and releasing in under a half second):

- Normal Operation: Will acknowledge/silence alarms in all modes of operation.
- Change Log Location Selected Position (if data logging is enabled).
- Will move selection position in the device menu.

Long Press (pressing the button and releasing after at least a half second):

- Start/reset COUNT Timer in COUNT mode.
- When Sigma Audio is enabled, pressing the ON/ACK button will take a new background reading and update the Sigma Audio level (in Rate Mode only).
- Reset/Zero: When in Rate mode, a long press of the ON/OFF button will reset/zero the averaged rate. The minimum display will be shown before returning to the exposure rate. When Sigma Audio is enabled, Rate Reset is disabled.
- Will reset MAX mode display.

UNITS button:

Short Tap (pressing the button and releasing under a half second):

- Used to switch between Primary and Secondary units in all available modes.

Long Press (pressing the button and releasing for at least a half second):

- Used to toggle the display in COUNT mode between the timer and the reading.

AUDIO button:

Short Tap (pressing the button and releasing under a half second):

- Used to toggle the click audio ON or OFF. Click audio defaults to ON when the unit is powered up. When Sigma Audio is enabled, tapping the AUDIO button will toggle the Sigma Audio beep ON and OFF. Count Mode audio is disabled by default, but can be enabled through Lumic Software. Sigma audio is disabled in count mode.

Long Press (pressing the button and releasing for at least a half second):

- Only used in the device menu. While viewing the Detector Overload parameter, a long press will allow the user to view the actual current level. Another long press will return the user to overload settings.

MODE button:

Short Tap (pressing the button and releasing under half a second):

- Used to advance between the three operating modes, RATE, MAX, and COUNT. Note that MAX and/or COUNT mode may be disabled from use. The device menu increments selected digit/text to the next available option.

RATE Mode Operation

In RATE mode, the current count rate will be displayed.

Long-pressing the ON/OFF button for at least a half second will reset the averaged rate before releasing the button. The Reset feature must be enabled through Lumatic Calibration software (see parameter: RateResetBtn) and will be disabled when Sigma Audio is enabled.

Tapping the UNITS button will switch the displayed value between the Primary and Secondary Units.

Tapping the AUDIO button will turn the “click” audio on/off. When Sigma Audio is enabled, pressing the AUDIO button will toggle the Sigma Audio beep on/off. If an alarm condition is present, tapping the ON/OFF button will acknowledge and turn off the continuous tone alarm audio. Under an alarm condition, the ALARM display indicator will remain on. Alarms are non-latching in RATE mode. When Sigma Audio is enabled, and an alarm condition is not present, a long press (at least a half second) of the ON/OFF button will reset the Sigma Audio alarm level. The Sigma count can only be reset in RATE Mode.

Figure 8: RATE mode display showing typical background radiation rate and the low-battery icon.

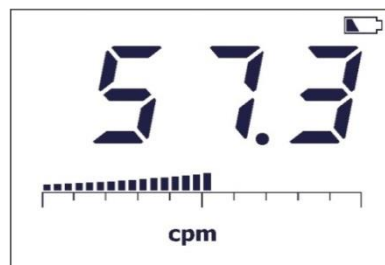

MAX Mode Operation

While in MAX mode, the highest detected count rate (since the last reset) is displayed. The word MAX will be displayed when in MAX mode.

Tapping the UNITS button will switch the displayed value between the Primary and Secondary Units.

Tapping the AUDIO button will turn the “click” audio on/off. When Sigma Audio is enabled, tapping the AUDIO button will toggle the Sigma Audio beep on/off.

Under a non-alarm or alarm condition, long pressing the ON/OFF button will reset the display. When Sigma Audio is enabled the Sigma Audio alarm level cannot be reset in Max Mode.

If an alarm condition is present, tapping the ON/OFF button once will acknowledge and turn off the continuous tone alarm audio. (The “click” audio will remain as selected under non-alarm conditions.) Under an alarm condition, the ALARM display indicator will remain on until the display is reset. Alarms in MAX mode latch with the display.

If other operational modes are available, tapping the MODE button will move to the next available operational mode.

Figure 9: MAX mode operation display with ALARM indicator.

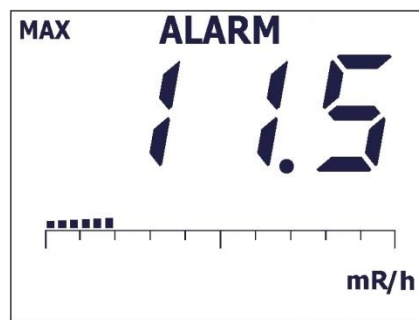

COUNT Mode Operation

When entering COUNT Mode from another operational mode, the currently selected COUNT Unit will be displayed for approximately one second. The purpose of COUNT mode is to count for a predetermined amount of time, and to display the results on the display. Note that the predetermined count time can be from 1 second to 10 minutes, or can be set to zero to enable continuous counting until stopped by the user.

Count mode operation is very flexible, depending on the units chosen. A common choice is for the count mode to just perform a scaler count for a specified time, with a resulting answer in counts (equaling detected radiation events).

There are two different options for COUNT mode, which can be set through software.

Go to “Device Count DisplayMode” in the Device or Others tab (depending on Software version). Enter/Select the desired option into the “Value” field.

- 0 – will only show the countdown timer while timer is active (default selection).
- 1 - will cycle between showing the countdown timer and the current reading.
- 2 - will only show the current gathered reading.

Note:

If the Data Logging Option is installed, tapping the LOG button will start a count and automatically log the result. A long press of the LOG button during the count will toggle the display between the timer and reading. Audio “clicks” are disabled in COUNT mode by default.

Device Count Mode Audio Mode will enable\disable click audio during a COUNT.

- 0 – Disabled (Mute icon will always be illuminated in COUNT mode.)
- 1 – Enabled

Note:

Sigma audio is disabled in Count Mode. If Sigma Audio and Count Mode Audio are enabled, click audio will be utilized in Count Mode. If a result in terms of activity is desired, the scaler count can also be in units of "d" or disintegrations. But if the count units are chosen to be cpm or cps, then the resulting answer is an averaged count rate over the time interval. Similarly, if count units of Bq or dpm are chosen, the resulting answer is an averaged disintegration rate.

Note:

If the user desires the instrument to show results in terms of disintegrations/area (eg. dpm/100cm² or Bq/cm²), then the appropriate factor should be placed in the Efficiency parameter.

Other choices are to have count mode units of R/h or Sv/h, in which case the COUNT mode result is an averaged exposure or dose rate. But if count mode units of R or Sv are chosen, the result is shown in accumulated exposure or accumulated dose over the chosen count time. The following tables lists the possibilities:

UNITS	RESULT
c	counts per count time
d	disintegrations per count time
cpm, cps	count rate averaged over the count time
dpm, Bq	disintegration rate, averaged over the count time
R/h, Sv/h	exposure or dose rate, averaged over the count time
R, Sv	integrated exposure or dose over the count time

In COUNT mode, operation depends on the current state of the Count Timer.

When the Count Timer is Ready:

- The display will show the Count Time.
- Tapping the UNITS button will switch between the Primary and Secondary Count Units. The newly selected Count Units will be displayed for approximately one second, and the display will then return to the Count Timer.
- Long-pressing ON/OFF button starts the Count Timer.
- If other operational modes are available, tapping the MODE button will move to the next available operational mode.

When the Count Timer is active:

- The display will show either Count Time (default), both Count Time and Counts, or just Counts, depending on Count Display Mode.
- Doing a long press (pressing the button and releasing after at least a half second) to the ON/OFF button will reset the Count Timer.
- Tapping the UNITS button will display the other unit if enabled.
- Click audio, if enabled, can be turned on and off by tapping the Audio button.
- If an alarm condition occurs, the ALARM display indicator will turn on. Alarm audio will sound after the count is completed if the result is over the alarm threshold. (If the count unit is an averaged rate it is possible for the ALARM icon to come on during the count, but if the averaged rate falls below the alarm threshold by the end of the count, no ALARM will be active.)
- If other operational modes are available, tapping the MODE button will cancel the current Count Timer and move to the next available operational mode.

When the Count Timer has finished:

- The display will show either the accumulated total for c, d, R, and Sv, or the timed ratemeter average for cps, cpm, Bq, dpm, or the average exposure or average dose in R/h and Sv/h.
- Tapping the UNITS button will switch between the Primary and Secondary Count Units.
- If an alarm condition occurred during the Timed Count, a continuous audio tone will sound, and the ALARM display indicator will turn on. Tapping the ON/OFF button once will acknowledge and turn off the continuous tone alarm audio. Doing a long press (pressing the button and releasing after at least a half second) to the ON/OFF button will clear the alarm condition and reset the Count Timer. Alarm audio will sound after the count is completed if the result is over the alarm threshold.
- If other operational modes are available, tapping the MODE button will move to the next available operational mode.

Figure 10: COUNT mode operation showing COUNT Timer of 5 minutes, 30 seconds.

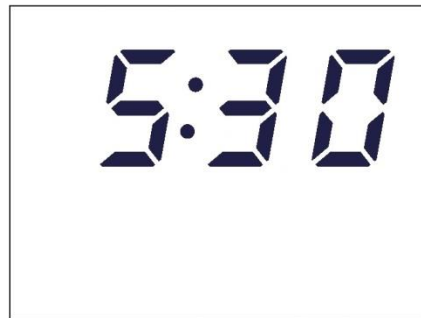

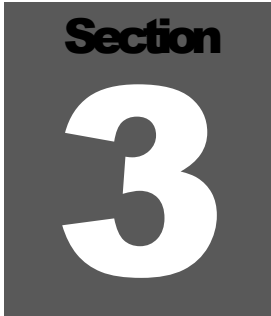
A dark gray square containing the word "Section" in a bold, sans-serif font at the top, and a large, white, stylized number "3" in the center.

Specifications

Detector:

Model 3019: internal CsI scintillator with 175 cpm/ μ R/hr sensitivity

Model 3006: 15.2 cm diameter x 2.5 cm thick (6 x 1 in.) plastic scintillator

HV Range: 400-1500 Vdc

Threshold Range: 20-100 mVdc

Sensitivity:

Model 3006: typically 2500 cps/ μ Sv/h (1500 cpm/ μ R/hr)

Model 3019: typically (175 cpm/ μ R/hr)

Linearity: reading within 10% of true value

Resolving Time: approximately 5 μ sec as defined by IEC 60325

Alarms: alarm setpoints adjustable over the display range

Sigma: sigma audio beeps when radiation level changes (if enabled)

Overload: high count rate saturation protection prevents false display of lower count rates

Zero Protection: after a user-settable number of seconds of no pulses from detector, unit will flash a zero reading and the alarm audio will be triggered

Dead Time Correction: employs first and second order corrections for extended performance

LCD Display: 3-digit LCD with large 20 mm (0.8 in.) digits, (k)cps, (k)cpm, (k)Bq, (k)dpm, (μ)(m)R(/h), (μ)(m)Sv(/h), low-battery indicator, MAX, ALARM, AUDIO

Detector Range:

Model 3019: background to 500 μ Sv/h (50 mR/hr)

Model 3006: background to 20 μ Sv/h (2 mR/hr)

Energy Range: 20 keV to 3 MeV

Headphone Jack (optional): 1/8 inch stereo jack for use with headphone for audio output. It is located to the left of the detector connector.

Backlight: built-in ambient light sensor automatically activates low-power LED backlight, unless internal dip switch is set to continuous-on (will reduce battery life)

User Controls:

- ON/OFF/– press to turn ON, tap to acknowledge alarms and silence alarm tone, long press to reset Sigma Audio alarm, long press to reset Rate, and hold for OFF
- MODE – alternates between RATE (count rate), MAX (captures peak rate), and COUNT (user-selectable preset count time from 0 to 10 minutes)
- AUDIO – turn “click” audio on/off, turn Sigma Audio beep on/off
- UNITS – changes the units from count rate (cpm, cps), to dose/exposure ($\mu\text{Sv/h}$, mR/h) or disintegration (dpm/Bq)

Response Time: user-selectable from 1 to 60 seconds, or Auto-Response Rate FAST or SLOW

Audio: 75 dB at 0.6 m (2 ft), approximately 4.5 kHz

Power: four alkaline “AA” batteries

Battery Life: approximately 750 hours of operation (as low as 100 hours with backlight configured for continuous-on), 16-hour low-battery warning

Maximum Current: 35 mAdc

Construction: high-impact plastic with water-resistant rubber seals and separate battery compartment

Temperature Range: -20 to 50 °C (-5 to 122 °F), may be certified for operation from -40 to 65 °C (-40 to 150 °F)

Environmental Rating: NEMA (National Electrical Manufacturers Association) rating of 5 or IP (Ingress Protection) rating of 53

Size:

Model 3019: 16.5 x 11.4 x 21.6 cm (6.5 x 4.5 x 8.5 in.) (H x W x L)

Model 3006: overall length with pole 188 cm (46.5 in.)

Weight:

Model 3019: 1.06 kg (2.3 lb)

Model 3006: 3.2 kg (7 lb)

Section 4

Setup Mode

Warning!

Only advanced users or administrators should consider changing any of the parameters in the following section. Incorrect settings could jeopardize the safety of users depending on this instrument.

Setup Overview

Your instrument has been shipped from Ludlum Measurements only after passing electronic checkout, a 24-hour burn-in process, and a careful calibration process. Calibration papers are supplied with each instrument shipped from Ludlum Measurements.

Recalibration should be accomplished after maintenance or adjustments have been performed on the instrument. Recalibration is not normally required following instrument cleaning or battery replacement. Recalibration does not require any special tools or software to perform.

Ludlum Measurements offers a full-service repair and calibration department. Not only do we repair and calibrate our own instruments, we also service most other manufacturers' instruments. Calibration procedures are available upon request for customers who choose to calibrate their own instruments.

Note:

Ludlum Measurements, Inc. recommends recalibration at intervals no greater than one year, assuming that regular operational checks are performed. Check the appropriate local, state, and federal regulations to determine required recalibration intervals.

Default Setup Values

	Setup Parameter	Default Value	Notes
P1-1	Calibration Constant Mantissa	110	110 e ⁸ Counts/R
P1-2	Calibration Constant Exponent	08	
P1-3	Dead Time Correction	0	Scintillator 5-10 μsec GM Tube 50-100
P1-4	Dead Time Correction 2 Mantissa	0	
P1-5	Dead Time Correction 2 Exponent	0	
P1-6	Efficiency	15.0	Efficiency %
P1-7	High Voltage Setpoint	800	Volts
P1-8	Pulser Threshold	35	millivolts
P1-9	Detector Current Overload Threshold	100	
P1-10	Loss of Count Alarm Time	60	Seconds
P2-1	Primary Units and Minimum Display	000 μR/hr	
P2-2	Primary Units Maximum Display	50.0 mR/hr	
P2-3	Primary Units RATE/ MAX Mode Alarm Point	000	Disabled
P2-4	Primary Count Units and Minimum Display	0.00 μR	
P2-5	Primary Count Alarm Point	000	Disabled
P3-1	Secondary Units and Minimum Display	000 cpm	Non-SI exposure rate
P3-2	Secondary Units and Maximum Display	999 kcpm	
P3-3	Secondary Units RATE/ MAX Mode Alarm Point	000	Disabled
P3-4	Secondary Count Units and Minimum Display	000 c	Non-SI exposure
P3-5	Secondary Count Alarm Point	000	Disabled
P4-1	Response Time	0	Enable Auto Response
P4-2	Auto-Response Rate	S	Slow Auto Response
P4-3	Operational Modes	0	All Modes Available
P4-4	Count Time	1:00	One Minute
P4-5	Auto Shutdown Time	0	Hours (0 – Disabled)
P4-6	Backlight Threshold	LO	Most Sensitive
P4-7	Sigma Audio	ON	Enabled

P5-1	Datalogging Mode (optional) Note: These options are editable through the Device Menu. They can only be manipulated when connected to Lumic Software.	1	Mode 1
P5-2	RTC Month	1	
P5-3	RTC Day	7	
P5-4	RTC Year	14	2014
P5-5	RTC Hours	16	24-hour format
P5-6	RTC Minute	30	
P5-7	RTC Second	00	

Entering Setup Mode

To enter setup mode, power down the Model 3006 or 3019, then turn the unit back ON. Following the display of the Firmware version, when the instrument has begun normal operation, press the MODE button three times (within four seconds) to enter Setup mode.

Note:

This process is different if you are in Sigma Mode, rather than in the “click” Audio Mode. While trying to enter Setup Mode from with Sigma Mode enabled, once the screen displays the firmware number and then begins the Sigma countdown, press the Mode button three times. Do not wait until the countdown is complete, which will prevent you from getting into the Setup Mode. There is no countdown for the “click” Audio Mode.

Entry to Setup Mode can be confirmed when the numeric portion of the display shows P-1, indicating the first setup page is selected. If you simply wish to view the parameters, select the desired Setup Page by tapping the MODE button. Tap the UNITS button to advance through the parameters available on the

selected Setup Page. To return to normal operation, advance back to the Setup Page selection by pressing the UNITS button. Pressing the UNITS button for at least a half second again will exit, or holding the UNITS button for approximately 5 seconds will also exit from anywhere in the menu.

Note:

If the menu is not exited properly, any changes made will not be saved.

SETUP PROTECT: The instrument parameters can be protected from unauthorized changes via the internal switch located on the Model 3006 or 3019 circuit board. To change the switch, open the battery compartment and remove the batteries. Next, loosen the six pan head screws that fasten the bottom cover.

Gently remove the bottom cover of the instrument. The DIP (dual in-line position) switch should now be visible in the upper left-hand corner of the circuit board.

To protect the instrument from changes in Setup mode, slide DIP Switch 2 (the rightmost switch) to the ON (forward) position. If DIP Switch 2 is in the OFF (back) position, changes are allowed in Setup mode. Once the DIP Switch is set as desired, gently replace the back cover and the six pan head screws. Install the batteries, and replace the battery cover.

There are three different options for protect mode, which can be set through Lumic Calibration Software. Locate the Parameter "Device Setup Prtct" in the Others tab. Enter the desired option into the "Value" field.

- **Normal:** All Parameters are protected from change through the device menu.
- **Bypass Alarms:** All Parameters except for Rate and Count Alarms are protected from change through the device menu.
- **Bypass Alarms Count:** All Parameters except for Rate Alarms, Count Alarms, and count time are protected from change through the device menu.

Note that with the DIP Switch 2 in the ON position, Setup mode may be entered and parameters viewed, but changes cannot be made.

DISPLAY BACKLIGHT 'Continuous On': The Model 3006 and 3019 display backlight can be set to remain on continuously during operation. Follow the steps above for **SETUP PROTECT**, but use DIP Switch 1 for display backlight selection. Setting DIP Switch 1 to the ON (forward) position will

configure the display backlight to remain on during operation. Set DIP Switch 1 to the OFF (back) position, and the display will be backlit only when light levels are low.

Note:

Setting the display backlight for continuous-on operation can result in reduced battery life. The backlight can be configured to always be off as well through the device menu or Lumatic Calibration Software.

Setup Mode Operation

Setup Page Selection: Once the Model 3006 or 3019 is in Setup mode, the Setup Page selection will be displayed on the LCD, and the Page number will be blinking, indicating it as the selected item. The number of available parameters per Setup Page will be displayed using the graph - the number of segments indicating the number of parameters. Tap the MODE button to choose the Setup Page. Once the desired Setup Page is shown, tap the UNITS button to move to the first parameter of that Setup Page. Long-pressing the UNITS button will exit the menu.

Figure 11: Setup Page Selection display (showing page 4).



Long-pressing the UNITS button, no matter what parameter is shown, will first return the user back to the Page Selection screen, and then exit if held for approximately 5 seconds in total. Exiting can also be accomplished by one or two individual presses (at least a half second) of the UNITS button, depending on where the user is in the menu. (If on the page selection, only one press will exit, but if viewing an individual parameter, two presses will be required.)

The following list of parameters lists the five setup pages and the parameters, in order, on each page.

List of Parameters (in order)

Page 1 (P-1)

- Calibration Constant Mantissa
- Calibration Constant Exponent
- Dead Time Correction 1
- Dead Time Correction 2 Mantissa
- Dead Time Correction 2 Exponent
- Efficiency
- High Voltage Setting
- Pulse Threshold
- Detector Current Overload Threshold
- Loss of Count Alarm Time

Page 2 (P-2)

- Primary Units and Minimum Display
- Primary Units Maximum Display
- Primary Units RATE/MAX Mode Alarm Point
- Primary COUNT Units and Minimum Display
- Primary COUNT Units Alarm Point

Page 3 (P-3)

- Secondary Units and Minimum Display
- Secondary Units Maximum Display
- Secondary Units RATE/MAX Mode Alarm Point
- Secondary COUNT Units and Minimum Display
- Secondary COUNT Units Alarm Point

Page 4 (P-4)

- Response Time
- Auto Response Rate
- Operational Modes
- Count Time

- Auto Shutdown Time
- Backlight Threshold
- Sigma Audio

Page 5 (P-5)

- Datalogging Mode
- Month
- Day
- Year
- Hour
- Minute
- Second

NOTE: Parameters on Page 5 (P-5) are not user editable using the instrument Setup Mode. To edit these parameters, please use the Ludlum Lumic Calibration or datalogging Software.

Setup Parameter Adjustment: Tap (pressing the button and releasing under half a second) the MODE button to adjust the value for the selected item. When the appropriate value is selected for that item, tap the ON/OFF button to move to the next item. When the desired value is displayed, tap the UNITS button to advance to the next parameter. The graph will display the total number of parameters available on the current Setup Page, and the current parameter's position will be blinking. *When the Model 3006 or 3019 is in PROTECT mode (dipswitch setting), the Setup parameters will cycle through to display the set values, but changes are not possible.*

The order of Setup parameters are as follows:

Setup Page 1

Calibration Constant Mantissa (Default 110) - Tap ON/OFF to select the value to adjust, and MODE to adjust the value. Value is used with Calibration Constant Exponent to express counts per R. Available values are:

- Ones Place (0-9)
- Tens Place (0-9)
- Hundreds Place (1-9)

Calibration Constant Exponent (Default 8) - Tap ON/OFF to select the value to adjust, and MODE to adjust the value. Value is used with Calibration Constant Mantissa to express counts per R. Available values are:

Ones Place (0-9)

Tens Place (0-1)

Dead Time Correction 1 (Default 0) - Tap ON/OFF to select the value to adjust, and MODE to adjust the value. Value is in microseconds. User should set to zero when checking instrument with pulser or function generator. Otherwise, higher count rates will result in non-linearities. Available values are:

Ones Place (0-9)

Tens Place (0-9)

Hundreds Place (0-9)

Dead Time Correction 2 Mantissa (Default 0) - Tap ON/OFF to select the value to adjust, and MODE to adjust the value. Available values are:

Ones Place (0-9)

Tens Place (0-9)

Hundreds Place (0-9)

Dead Time Correction 2 Exponent (Default 0) - Tap ON/OFF to select the value to adjust, and MODE to adjust the value. Available values are:

Value between (-6 to -12)

Efficiency (Default 15.0%) - Tap ON/OFF to select the value to adjust, and MODE to adjust the value. Available values are:

Ones Place (0-9)

Tens Place (0-9)

Hundreds Place (0-9)

Number of Decimal Places (0 or 1)

Normally the efficiency is used on a per detector basis or 4pi basis, i.e. the efficiency of the detector is calculated by dividing the count rate received from a source by the total disintegration rate of the source. When either dpm or Bq units are chosen, the use of the 4pi efficiency allows the display of the source size or activity on the instrument display.

But if the user desires to have the Model 3006 or 3019 show results in terms of dpm/100 cm², the user could manipulate the efficiency to produce this result by multiplying the efficiency times the ratio of the detector area to 100 cm². For example, using a detector with an area of 15 cm², if we start with 10% efficiency to measure in dpm, then the parameter could be changed to 1.5% to measure in dpm/100 cm².

Or likewise for Bq/cm², efficiency could be calculated as: efficiency = count rate/disintegration rate*detector area (in cm²). For example, with the same detector as above with an area of 15 cm², and starting with an efficiency value of 15%, then the parameter could be changed to 225% to measure in Bq/cm².

High Voltage (Default 800 Volts) - Tap ON/OFF to select the value to adjust, and MODE to adjust the value. Value is in Volts. Available values are:

Ones Place (0-9)

Tens Place (0-9)

Hundreds Place (0-9)

k Multiplier (on/off)

Note: k multiplier also activates left-most decimal point. If k multiplier is used, Hundreds Place value is limited to 0 and 1.

Pulser Threshold (Default 35 millivolts) - Tap ON/OFF to select the value to adjust, and MODE to adjust the value. Available values are:

Ones Place (0-9)

Tens Place (0-9)

Hundreds Place (0-1)

Note: Audio is enabled for this parameter only for ease of setting.

Detector Current Overload Threshold (Default 100) - Tap ON/OFF to select the value to adjust, and MODE to adjust the value. Setting the Detector Current Overload Threshold to 0 disables the Current Overload Alarm. Available values are:

Ones Place (0-9)

Tens Place (0-9)

Hundreds Place (0-9)

A long press (at least a half second) of the AUDIO button will cause the display to show the actual live current reading. Repeating this process will return you back to the overload threshold setpoint.

Loss of Count Alarm Time (Default 60 seconds) - Tap ON/OFF to select the value to adjust, and MODE to adjust the value. Setting the Loss of Count Alarm Time to 0 disables the alarm. Value is in seconds. Available values are:

Ones Place (0-9)

Tens Place (0-9)

Hundreds Place (0-9)

Setup Page 2

Primary RATE/MAX Units and Minimum Display (Default 0.00 μ R/h) - Tap ON/OFF to select the value to adjust, and MODE to adjust the value. Available values are:

Number of Decimal Places (0, 1, or 2)

Minimum Units – (See list below.)

cpm	kcpm	cps	kcps	dpm	kdpm	Bq
kBq	μ R/h	mR/h	R/h	μ Sv/h	mSv/h	Sv/h

Primary Units RATE/MAX Maximum Display (Default 999 mR/hr) - Tap ON/OFF to select the value to adjust, and MODE to adjust the value. Units will be the same as selected earlier with Primary Units. Available values are:

Ones Place (0-9)

Tens Place (0-9)

Hundreds Place (0-9)

Number of Decimal Places (0, 1, or 2)

Range (k on or off – cpm, cps, dpm, Bq; μ , m or none for R/h and Sv/h)

Primary Units RATE/MAX Mode Alarm Point (Default 000) - Tap ON/OFF to select the value to adjust, and MODE to adjust the value. Units will be the same as selected earlier with Primary Units. The ALARM LCD Segment will be on to indicate an Alarm parameter. Set this Alarm Point to 000 to disable. Available values are:

Ones Place (0-9)

Tens Place (0-9)

Hundreds Place (0-9)

Number of Decimal Places (0, 1, or 2)

Range (k on or off – cpm, cps, dpm, Bq; μ, m or none for R/h and Sv/h)

Note: If the Primary Units has changed to a value other than that used to previously set this Alarm Point, the Alarm Point will be reset to 000.

Primary Count Units and Minimum Display (Default 0 μR) - Tap ON/OFF to select the value to adjust, and MODE to adjust the value. Available values are:

Number of Decimal Places (0, 1, or 2)

Minimum Units depend on the selected Primary Units– (See list below.)

Primary Units	Primary Count Units Available	Primary Units	Primary Count Units Available
cps kcps	cps c	μR/h mR/h R/h	μR/h μR mR/h mR R/h R
cpm kcpm	cpm c		
Bq kBq	Bq d	μSv/h mSv/h Sv/h	μSv/h μSv mSv/h mSv Sv/h Sv
dpm kdpm	dpm d		

Primary Count Alarm Point (Default 000) - Tap ON/OFF to select the value to adjust, and MODE to adjust the value. Units will be the same as selected earlier with Primary Count Units. Primary Count Units of c or d will not be displayed, but mR or μSv will. The ALARM LCD Segment will be on to indicate an Alarm parameter. Set this Alarm Point to 000 to disable. Available values are:

Ones Place (0-9)

Tens Place (0-9)

Hundreds Place (0-9)

Number of Decimal Places (0, 1, or 2)

Range (k on or off – cpm, cps, dpm, Bq; μ, m or none for R/h and Sv/h)

Note: If the Primary Count Units has changed to a value other than that used to previously set this Alarm Point, the Alarm Point will be reset to 000.

Setup Page 3

Secondary RATE/MAX Units and Minimum Display (Default 0 cpm) - Tap ON/OFF to select the value to adjust, and MODE to adjust the value. Set to OFF to disable Secondary RATE/MAX Units. Available values are:

Number of Decimal Places (0, 1, or 2)

Minimum Units – (See list below).

cpm	kcpm	cps	kcps	dpm	kdpm	Bq
kBq	μ R/h	mR/h	R/h	μ Sv/h	mSv/h	Sv/h

Secondary Units RATE/MAX Maximum Display (Default 999 kcpm) - Tap ON/OFF to select the value to adjust, and MODE to adjust the value. If the Secondary Units is off, this parameter will be skipped. Units will be the same as selected earlier with Secondary Units. Available values are:

Ones Place (0-9)

Tens Place (0-9)

Hundreds Place (0-9)

Number of Decimal Places (0, 1, or 2)

Range (k on or off – cpm, cps, dpm, Bq; μ , m or none for R/h and Sv/h)

Secondary Units RATE/MAX Mode Alarm Point (Default 000) - Tap ON/OFF to select the value to adjust, and MODE to adjust the value. If the Secondary Units is off, this parameter will be skipped. Otherwise, units will be the same as selected earlier with Secondary Units. The ALARM LCD Segment will be on to indicate an Alarm parameter. Set this Alarm Point to 000 to disable. Available values are:

Ones Place (0-9)

Tens Place (0-9)

Hundreds Place (0-9)

Number of Decimal Places (0, 1, or 2)

Range (k on or off – cpm, cps, dpm, Bq; μ , m or none for R/h and Sv/h)

Note: If the Secondary Units has changed to a value other than that used to previously set this Alarm Point, the Alarm Point will be reset to 000.

Secondary Count Units and Minimum Display (Default 0 c) - Tap ON/OFF to select the value to adjust, and MODE to adjust the value. If the Secondary Units is off, this parameter will be skipped. Available values are:

Number of Decimal Places (0, 1, or 2)

Minimum Units depend on the selected Primary Units. See list below.

Primary Units	Primary Count Units Available	Primary Units	Primary Count Units Available
cps kcps	cps c off	μR/h mR/h R/h	μR/h μR mR/h mR R/h R off
cpm kcpm	cpm c off		
Bq kBq	Bq d off	μSv/h mSv/h Sv/h	μSv/h μSv mSv/h mSv Sv/h Sv off
dpm kdpm	dpm d off		

Secondary Count Alarm Point (Default 000) - Tap ON/OFF to select the value to adjust, and MODE to adjust the value. If the Secondary Units is off, this parameter will be skipped. Otherwise, units will be the same as selected earlier with Secondary Count Units. The ALARM LCD Segment will be on to indicate an Alarm parameter. Set this Alarm Point to 000 to disable. Available values are:

Ones Place (0-9)

Tens Place (0-9)

Hundreds Place (0-9)

Number of Decimal Places (0, 1, or 2)

Range (k on or off – cpm, cps, dpm, Bq; μ, m or none for R/h and Sv/h)

Note: If the Secondary Count Units has changed to a value other than that used to previously set this Alarm Point, the Alarm Point will be reset to 000.

Setup Page 4

Response Time (Default 0 - auto) – Tap ON/OFF to select the value to be adjusted and MODE to adjust the value. Setting the Response Time to a fixed value is useful primarily when performing surveys to a fixed MDA (Minimum Detectable Activity) level. Setting the Response Time to 0 will enable the Auto-Response mode (see the next parameter). Available values for the Response Time (in seconds) are:

Ones Place (**0-9**)

Tens Place (**0-6**, **6** forces max Response Time of 60)

Auto-Response Rate (Default S) - Tap MODE to select Fast (**F**) or Slow (**S**).

When operating in Auto-Response mode, the instrument will vary the Response Time based on the Auto-Response Rate selected (**Fast** or **Slow**) and the current Count Rate. The following table shows the response time for different count rates when these auto response modes are chosen:

Count Rate	Auto Response Time – Fast (Seconds)	Auto Response Time – Slow (Seconds)
Less than 3 kcpm (50 cps)	10.5	21
Between 3 kcpm and 4 kcpm (67 cps)	8.4	16.8
Between 4 kcpm and 6 kcpm (100 cps)	6.3	12.6
Between 6 kcpm and 12 kcpm (200 cps)	4.2	8.4
More than 12 kcpm	2.1	4.2

The Model 3006 and 3019 also utilize a Step function in Auto Response mode, which enables faster response to a significant increase or decrease in Count Rate. When the instrument detects a sudden change in count rate from the detector, the response time is reduced to 1 second to quickly show the new value.

Operational Modes (Default 0 - All modes available) - Tap MODE to adjust the value. Available values are:

0 – RATE, MAX, and COUNT Modes

1 – RATE and MAX Modes only

2 – RATE and COUNT Modes only

3 – RATE Mode only

Count Time (Default 1 minute) - Tap ON/OFF to select the value to adjust and MODE to adjust the value. Setting Count Time to 0 enables continuous count until reset. If 9 minutes are selected, then the maximum seconds value is 60; otherwise, the maximum seconds value is 59. Available values are:

Ones Place (0-9)

Tens Place (0-6, 6 only available if minutes value is 19)

Hundreds Place (0-9)

Note:

The UNITS button can be used to advance to the next parameter. To end Setup mode and save the current setting, press and hold the UNITS button for approximately 5 seconds, or press the UNITS button for at least a half second two times.

Auto Shutdown Time (Default 0 - off) - Tap MODE to adjust the value in hours. If non-zero, unit will automatically power down after so many hours since the last button press. Setting Auto Shutdown Time to 0 disables Auto Shutdown. Available values are:

Ones Place (0-9) hours

Backlight Threshold (Default LO – most sensitive) - Tap MODE to adjust the value. Available values are:

LO – Backlight comes on at a higher ambient light level

There are two different options for **Backlight Threshold LOW**, which can be set through software. Locate the Parameters in the Others tab. Enter the desired number into the “Value” field.

- **Low Light Turn On:** The backlight will set the threshold that the backlight will turn on at. (This should be lower than the Turn Off value.)
- **Low Light Turn Off:** This value will set the threshold that the backlight will turn off at. (This should be higher than the Turn On value.)

HI – Backlight comes on at a lower ambient light level

There are two different options for **Backlight Threshold HIGH**, which can be set through software. Locate the Parameters in the Others tab. Enter the desired number into the “Value” field.

- **High Light Turn On:** This value will set the threshold that the backlight will turn on at. (This should be lower than the Turn Off value.)
- **High Light Turn Off:** This value will set the threshold that the backlight will turn off at. (This should be higher than the Turn On value.)

OFF – Disables backlight

Sigma Audio (Default ON) - Tap MODE to adjust the value. Available values are:

ON – Sigma Audio Enabled

OFF – Sigma Audio Disabled (Normal 'Click' Audio active)

Note

The Sigma Mode may not work properly until the 8-second background is completed. If the 8-second background count is too low or too high, the device will continually beep until an acceptable background count rate (500 cpm - 200 kcpm) is obtained. Sigma Audio is disabled in Count Mode, If Count audio and Sigma Audio are enabled Count audio will be "click" audio.

Setup Page 5

NOTE: Parameters on Page 5 (P-5) are not user editable using the instrument Setup Mode. To edit these parameters, please use the LMI Lumic Datalog Software.

Datalogging Mode (Default 1) – Displays the current Datalogging Mode selection for the device. Valid values are: 1-3

Month (Default 1) – Displays the month of the Real Time Clock. Available values are: 1-12

Day (Default 7) – Displays the numerical day of the Real Time Clock. Available values are: 1-31

Year (Default 14) – Displays the decade and year of the Real Time Clock. Available values are: 00-99

NOTE: Valid year range is 2000-2099.

Hour (Default 16) – Displays the hour of the Real Time Clock in 24-hour format. Available values are: 0-23

Minute (Default 30) – Displays the minute of the Real Time Clock. Available values are: 00-59

Second (Default 00) – Displays the second of the Real Time Clock. Available values are: 00-59

Section
5**Datalogging**

The datalogging feature of the Model 3006 and 3019 allows the user to log radiation readings with the use of a handle-mounted LOG button. Data can be logged in any of the operational modes (RATE, MAX and COUNT). Up to 1000 data points can be taken and stored internally. Depending on the chosen Datalogging Mode, the user can quickly save logged data using a single Location ID, or select from up to 250 stored Location IDs. A Real Time Clock (RTC) is utilized to time and date stamp each datalog entry.

The saved log data and stored location IDs can be viewed, downloaded, and erased using the LMI Lumic software kit, which includes a USB cable. Editing of datalogging parameters and RTC via setup mode on the instrument is disabled.

Setup of the datalogging parameters is also done through the LMI Lumic software. The advanced user or administrator can set:

- Datalogging Mode
- Real Time Clock (RTC) Values
- Location IDs

Datalogging Operation – Mode 1

Datalogging Mode 1 will store the logged data using only the first Location ID in the Location ID table.

- When the LOG button is pressed, the current radiation reading and other log data is saved along with the first Location ID in the format specified in specifications at the end of this section.
- In COUNT Mode:
 - With a set count time, the LOG button is disabled until completion of a Scaler count.
 - For a continuous Scaler count (Scaler time is 0), the LOG button is enabled at all times.
- For approximately 2 seconds, the LCD will display the Datalog Table index for the newly saved log data.

Figure 12: Display showing a Datalog Table index of 12.



- After displaying the Datalog Table index, the instrument will return to the previous mode of operation.
- The Datalog Table is linear; once the table is full, no further writes will be allowed until the Datalog Table is erased.
- If an attempt is made to write to a full Datalog Table, a beep will sound and the maximum Datalog Table index (1.00 k) will be displayed for about 2 seconds. The instrument will then return to the previous mode of operation.

Datalogging Operation – Mode 2

Datalogging Mode 2 will allow the user to choose the Location ID (by Location ID Table index) to store with the logged data.

- When the LOG button is pressed, the current radiation readings and other log data are temporarily stored.
- In COUNT Mode: Datalogging Mode 1 is always utilized
 - With a set count time, the LOG button is disabled until completion of a Scaler count.
 - For a continuous Scaler count (Scaler time is 0), the LOG button is enabled at all times.
- The LCD display will show a possible Location ID Table index for the user. The index will be auto-incremented from the previously used index.

Figure 13: Display showing a Location ID Table index of 36.



- The ones digit of the index will be blinking, indicating a changeable value. The user may then enter the preferred Location ID Table index by tapping the ON/OFF (to select the digit) and MODE (to change the value) buttons as in Setup mode.
- Once the user has the preferred Location ID Table index entered, tap the LOG button to save the log data.
- For approximately 2 seconds the LCD will display the Datalog Table index for the newly saved log data (*See Figure 12*).
- After displaying the Datalog Table index, the instrument will return to the previous mode of operation.
- The Datalog Table is linear; once the table is full, no further writes will be allowed until the Datalog Table is erased.

Datalogging Operation – Mode 3

Datalogging Mode 3 will automatically record data log records using the current location with the user settable auto log interval (settable to record every 1 to 1800 seconds).

- When the Device is turned on and in RATE or MAX mode, the current radiation reading and other log data is recorded at the set interval.
- In SCALER Mode:
 - Auto log will be paused and will only log at the completion of each count.
 - For a continuous Scaler count (Scaler time is 0), logs will be recorded until the Data Log Table is erased.
- The Data Log Table is linear; once the table is full, no further writes will be allowed until the Data Log Table is erased.

Note:

Tapping the LOG button will start a count and automatically log the result. Long-pressing the LOG button during the count will toggle the display between the timer and reading.

Specifications

Handle mounted LOG button

Real Time Clock (RTC)

Internal Storage of up to 250 32-byte Location IDs

Internal Storage of up to 1000 64-byte Datalog records

Datalog format:

- Format Version (1 Byte)
- Month (1 Byte)
- Year (2 Bytes)
- Day (1 Byte)
- Hour (1 Byte)
- Minutes (1 Byte)
- Seconds (1 Byte)
- Logged Value (4 Bytes)
- Range (1 Byte)

- Units (1 Byte)
- Mode (1 Byte)
- Detector Number (1 Byte)
- Status (1 Byte)
- Reserved (2 Bytes)
- Elapsed Count Time in seconds (4 Bytes)
- Scaler Count Time in seconds (4 Bytes)
- Location ID (32 Bytes)

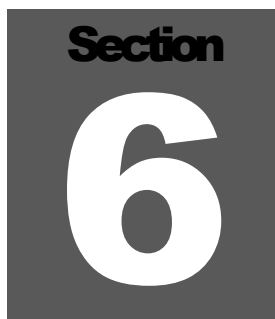
A dark gray square containing the word "Section" in a bold, white, sans-serif font at the top, and a large, white, sans-serif number "6" in the center below it.

Software

Connecting to Software

Most Model 3006 and 3019 instruments are sent with a standard 2-meter cable. (A 5-meter cable can be provided if requested. However, any cable above 2 meters may have issues with some USB-hubs/computers.)

In order to connect an instrument to the computer, please connect one end of the USB cable to the instrument first, and then the other end to the computer. Do not connect both ends to the computer.

Please allow Windows® a moment to install the proper HID drivers for the instrument before trying to use any software.

Note:

We recommend that you plug the USB cable into the back of your PC that connects to your motherboard instead of a USB hub.

Note:

Some parameters may only be edited in software, such as the backlight thresholds, COUNT Display Mode, COUNT Audio Mode, and Setup prtct.

Extended Features

This section describes the features that have been added to the firmware since the last software release. If the version of your Lumatic Calibration Software is higher than 1.1.0.4, these parameters may have been moved to the Device tab.

Device Count DisplayMode

- 0 – timer active only (default selection).
- 1 – toggle between timer and the current reading.
- 2 – current reading only.

Device Count AudioMode will enable/disable click audio during a COUNT.

- 0 – Disabled (Mute icon will always be illuminated in COUNT mode.)
- 1 - Enabled

Device RateResetBtn

- 0 - Disabled
- 1 - Enabled

Device Setup Prtct

- Normal
- Bypass Alarms
- Bypass Alarms Count

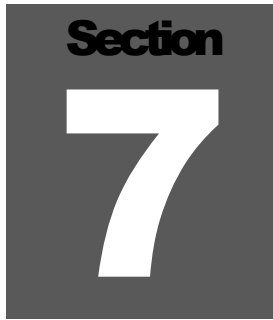

Advanced Features

Dead Time Correction

All pulse counting detectors have a “dead time” in which the detector is unable to register another event. In relatively low fields this is not an issue. However, as the field strength approaches the high end of the detector’s range, dead time causes the pulse rate to become non-linear with respect to the real radiation field. Dead time correction is used to linearize the measurements, allowing a wider linear response range for a given detector.

This instrument uses a second order dead time correction using the equation

$$\text{rate}_c = \frac{\text{rate}_m}{[1 - (DTC_1 * \text{rate}_m) + (DTC_2 * \text{rate}_m^2)]}$$

where DTC_1 and DTC_2 are the dead time correction coefficients, rate_m is the measured count rate, and rate_c is the corrected rate.

Dead time correction coefficients are configured through the device setup menu or through *Lumic Calibration* software. *Lumic Calibration* software also includes a wizard that will automate finding and setting the correct coefficients.

DTC_1 is represented in micro seconds (μs) on the device setup menu and in the software. The equation must be calculated in terms of seconds (s) and must be scaled appropriately. DTC_2 has more complex units and are not shown. However, the representation of the coefficient on the setup menu and in software do not require scaling.

Note:

Setting the DTC_2 to zero will disable the second order correction, while setting DTC_1 to zero will disable both, regardless of the value of DTC_2 .

Units

Depending on the chosen display units, different features will affect value of the reading. The following table lists the features that apply to each of the display units.

Unit	Feature
cpm cps counts	Dead time correct
Bq dpm disintegrations	Dead time correction Efficiency
R/h R	Dead time correction Calibration constant
Sv/h Sv	Dead time correction Calibration constant R to Sv conversion

These apply to all modes.

R to Sv Conversion

The **R to Sv conversion** is a setting available in *Lumic Calibration* software. It defines the conversion factor between R and Sv. Since the **calibration constant** is directly tied to R (counts per R), calibrating Sv requires a correct setting of both **calibration constant** and **R to Sv conversion**.

Example: A **R to Sv conversion** factor of 0.0106 will cause a reading of 10.6 mSv/h while in a 1 R/h field

Software Calibration Tools

Lumic Calibration software includes wizards that will assist in calibrating and plateauing detectors. After configuring the wizard for a specific detector, the wizard will automate much of the data collection and calculation required for calibration.

Instrument Calibration

This instrument provides the ability to digitally enter a voltage for both high voltage and threshold. As such, the instrument itself needs to be calibrated. This happens at the factory when the instrument is built and should not require re-calibration. However, if calibration is required (due to board rework, etc.) the calibration settings are available in *Lumic Calibration* software.

Other Device Data

The following parameters on the instrument allow recording import device information within the device:

Firmware Version: This is a read-only presentation of the firmware version. With a version of 4983xnyy.zzzz, the xyy will show up on the device screen during the power-on sequence and signifies the released version.

Device – Model Name: This should match the model name on the front face of the instrument.

Device – Serial Number: This should match the serial number of the instrument.

Detector – Model: This can store the model of the detector the instrument was calibrated for.

Detector – Serial Number: This can store the serial number of the detector the instrument was calibrated for.

Real-time Streaming

Lumic Calibration software and this instrument have the ability to stream data from the instrument to a computer. The data can be viewed live inside software or can be recorded on file.

Multiple user-selected parameters can be streamed simultaneously including:

- Remote display of the screen
- All unit values
- Device status
- Live HV current measurement

Section
8**Safety Considerations****Environmental Conditions for Normal Use**

Indoor or outdoor use (While rain resistant, user is cautioned to avoid getting water through detector opening.)

No maximum altitude

Temperature range of -40 to 65 °C (-40 to 150 °F)

Maximum relative humidity of less than 95% (non-condensing)

Pollution Degree 3 (as defined by IEC 664): (Occurs when conductive pollution or dry nonconductive pollution becomes conductive due to condensation. This is typical of industrial or construction sites.)

Not certified for use in an explosive atmosphere

Warning Markings and Symbols**Caution!**

The operator or responsible body is cautioned that the protection provided by the equipment may be impaired if the equipment is used in a manner not specified by Ludlum Measurements, Inc.

The Model 3006 and 3019 Background Survey Meter is marked with the following symbols:



CAUTION (per ISO 3864, No. B.3.1): designates hazardous live voltage and risk of electric shock. During normal use, internal components are hazardous live. This instrument must be isolated or disconnected from the hazardous live voltage before accessing the internal components. This symbol appears on the side panel. Be sure to take the precautions noted in the next section whenever necessary.



The “**crossed-out wheellie bin**” symbol notifies the consumer that the product is not to be mixed with unsorted municipal waste when discarding. Each material must be separated. The symbol is placed on the label located on the side panel. See section 7, “Recycling,” for further information.



The “CE” mark is used to identify this instrument as being acceptable for use within the European Union.

Cleaning and Maintenance Precautions

The instrument may be cleaned externally with a damp cloth, using only water as the wetting agent. Observe the following precautions when cleaning or performing maintenance on the instrument:

1. Turn the instrument OFF and remove the batteries.
2. Allow the instrument to sit for one minute before cleaning the exterior or accessing any internal components for maintenance.

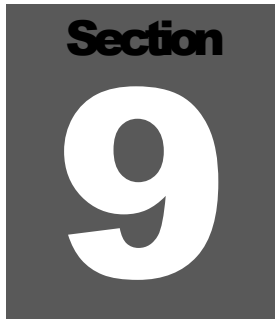
A dark gray square containing the word "Section" in a bold, white, sans-serif font at the top. Below it is a large, white, stylized number "9".

Revision History

NOTE: This section of the manual will be updated with each revision of the Model 3006 or 3019 in order to document changes over time. Ludlum Measurements' policy is to provide free software upgrades to instruments for the life of the instrument.

May 2014: New manual.

November 2014: Added a note explaining entering Setup Mode while in Sigma Mode on page 4-3. Added a note on page 4-14 regarding the audio and background.

January 2015: Deleted Display Range information from Specs and replaced with Detector Range to avoid customer confusion.

March 2015: Updated photo on front cover.

April 2015: Updated Setup Parameter Defaults Table on page 4-2 and Defaults in Setup Mode Operation Section to reflect current values.

February 2016: Added Appendix A in the back for Energy Response graph.

August 2016: Instrument now automatically comes with datalogging capability. Section 5 is now Datalogging section and paragraph added to Intro, Section 1.

November 2016: Added information about the new parameters, Backlight Threshold, Device COUNT DisplayMode, Device COUNT AudioMode, and Dead Time Correction 2. Added Section 6 Connection to Software.

March 2017: Firmware was updated, which affects Sections 2 and 4 with more screens and turn-on and changes in what buttons do and how to press/tap them. Added Sigma Audio details in Sections 2 and 3. Updated Audio in Section 3 Specifications and added headphone jack. In Section 4 updated Default Values including adding P5 values, added a note at the bottom of page 4-3, added sentence about backlight configuration in note at end of Entering Setup Mode section on page 4-4, changed values of Dead Time Correction 2 Exponent (Default 0) to -6 to -12, updated Response Times in table on page 4-

14. Added Section 5 Datalogging (incorporating in order to eventually do away with separate Datalogging Option manual). Section 6 updated to Software with Connecting to Software and Extended Features as sub-sections. Added Section 10 Options.

June 2017: Added Energy Range to Specifications. Corrected Energy Response Curve in Section A and added Ambient Dose Equivalent Energy Response Curve.

October 2017: Corrected ON/ACK to ON/OFF throughout. Deleted references to dual audio, does not apply. Corrected presses/taps where necessary in Sections 2 and 4. Updated the Detector Over Range graphic on page 2-5. Added description of Setup Page 5 to Section 4. Added Advanced Features as Section 7.

April 2018: Added information about the Model 3006 to this manual, making this manual for both the Model 3019 and Model 3006, including pictures in Section 1 and specification numbers specific to the Model 3006 in Section 3. Added Linearity, Sensitivity, and Overload to Specifications Section 3 for both. Added Energy Response graphs in Appendix A for Model 3006. Added Drawing 519 x 130A to front.

September 2018: Changed the IP rating from 65 to 53 in Specifications, per further testing.

September 2019: Added paragraph to page 1-2 about dead time correction and added Dead Time Correction to Specifications, page 3-1; changed NEMA rating from 4x to 5.

Section
10

Recycling

Ludlum Measurements, Inc. supports the recycling of the electronics products it produces for the purpose of protecting the environment and to comply with all regional, national, and international agencies that promote economically and environmentally sustainable recycling systems. To this end, Ludlum Measurements, Inc. strives to supply the consumer of its goods with information regarding reuse and recycling of the many different types of materials used in its products. With many different agencies – public and private – involved in this pursuit, it becomes evident that a myriad of methods can be used in the process of recycling. Therefore, Ludlum Measurements, Inc. does not suggest one particular method over another, but simply desires to inform its consumers of the range of recyclable materials present in its products, so that the user will have flexibility in following all local and federal laws.

The following types of recyclable materials are present in Ludlum Measurements, Inc. electronics products, and should be recycled separately. The list is not all-inclusive, nor does it suggest that all materials are present in each piece of equipment:

- | | | |
|----------------|----------|------------------------------|
| Batteries | Glass | Aluminum and Stainless Steel |
| Circuit Boards | Plastics | Liquid Crystal Display (LCD) |

Ludlum Measurements, Inc. products that have been placed on the market after August 13, 2005, have been labeled with a symbol recognized internationally as the “crossed-out wheelie bin,” which notifies the consumer that the product is not to be mixed with unsorted municipal waste when discarding. Each material must be separated. On the Model 3006 or 3019, the symbol will be placed on the serial number label located on the side of the instrument.

The symbol appears as such:

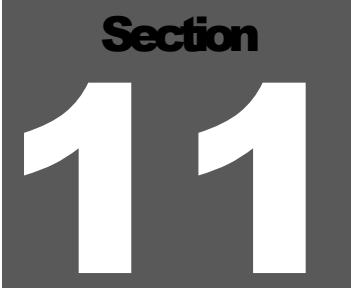

A dark gray square graphic with the word "Section" in white at the top. Below it, the number "11" is written in large, white, bold digits.

Options

Lumic Calibration Kit (part # 4498-1018): The kit includes calibration software plus the cable required for calibration. The software allows users to collect data and read, print, and save device parameters. It allows administrators to adjust device parameters from one device to another.

Lumic Datalogging Kit (part # 4498-1019): The kit includes datalogging software plus the required cable. The software allows users to collect data and read, print, and save device parameters. It allows administrators to adjust device parameters from one device to another.

Model 3000 Series Datalogging Option (part # 4498-479): This option is available to those who already own a Model 3000 series instrument but chooses to upgrade their existing instrument to datalogging capability. This option includes firmware plus an instrument handle incorporating a datalogging button. The handle-mounted LOG button saves the instrument reading along with a user-selected Location ID, date/time, and other key values.

Headphone Option (part # 4498-555): This provides the Model 3000 series of instruments with a jack and circuitry required for a standard headphone plug. Ludlum Measurements also offers mono/stereo headphones with volume control.

Shoulder Strap (part # 4498-868): This adjustable, padded strap comes with a kit to attach it to a Model 3000 series instrument.

Protective Storage/Transport Case (part # 2312958): This is a medium-sized, foam-padded, rugged case that can be secured with a padlock. It is fitted with a manual pressure relieve valve for air transport, providing water and dust-proof protection for sensitive instruments.

Appendix
A

Energy Response

Model 3019 Exposure Energy Response Relative to Cs-137

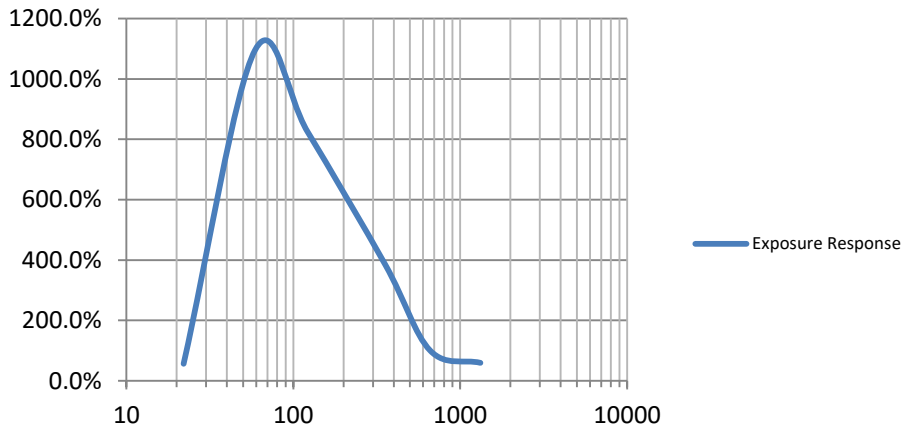

Model 3019 Ambient Dose Equivalent Energy Response Relative to Cs-137

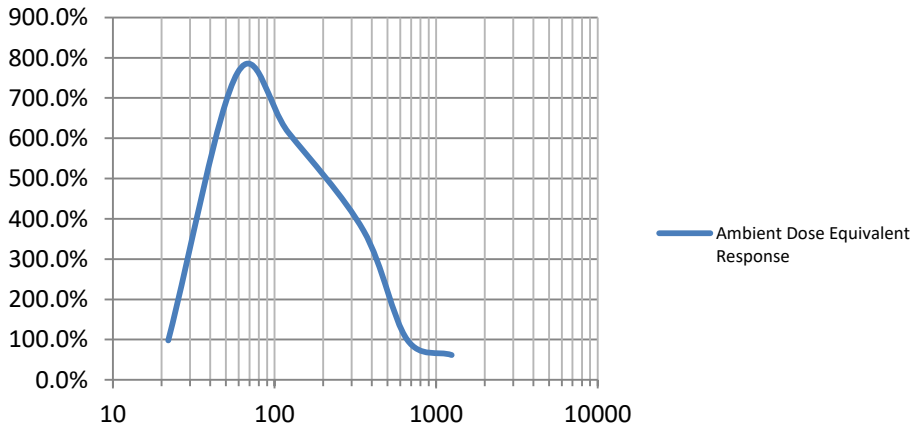

Model 3006 Exposure Energy Response Relative to Cs-137

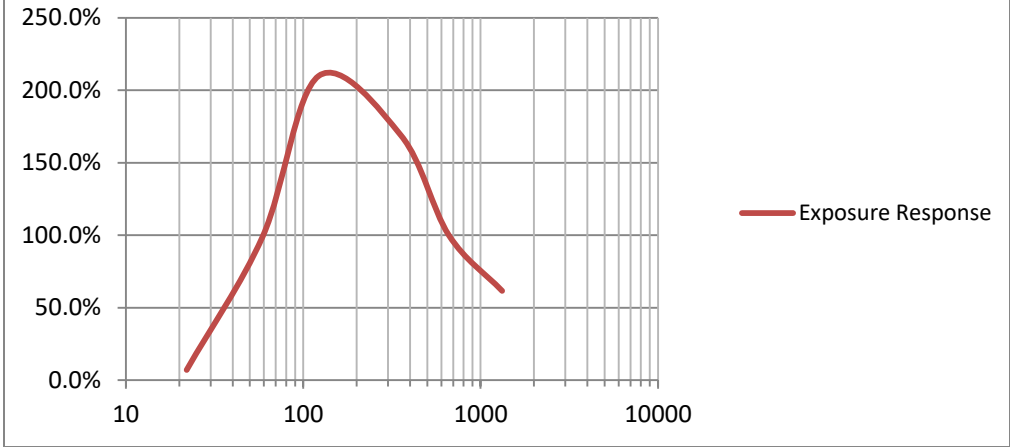

Model 3006 Ambient Dose Equivalent Energy Response Relative to Cs-137

